

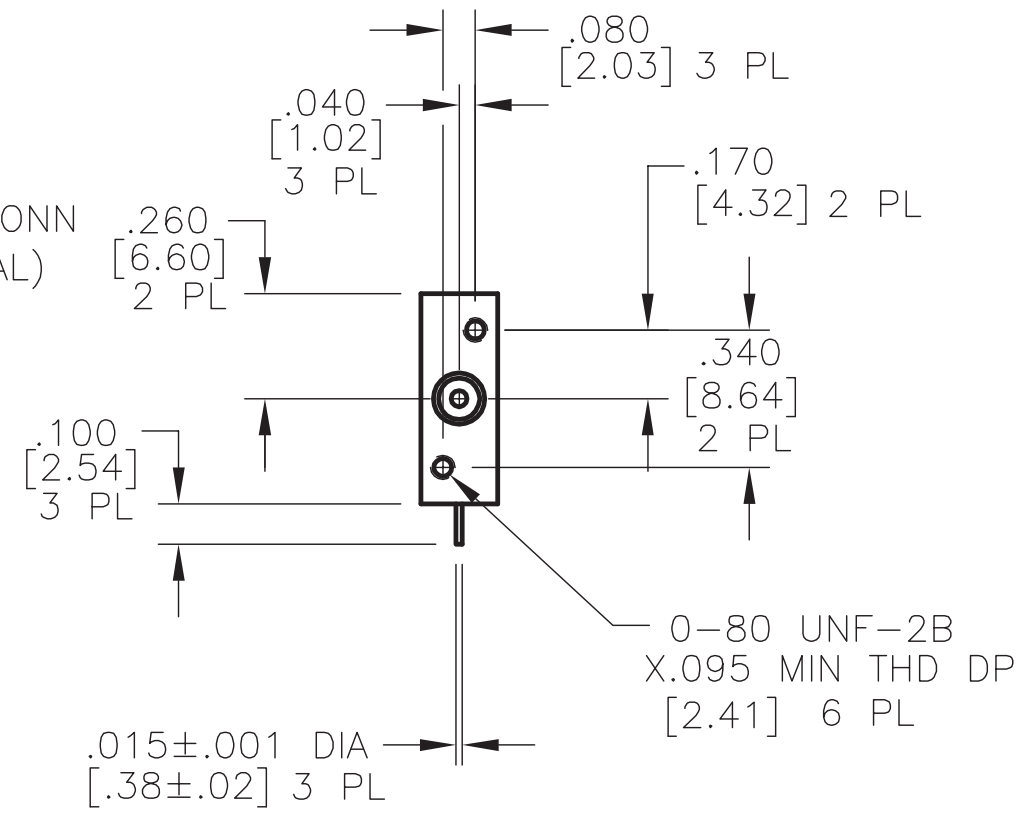

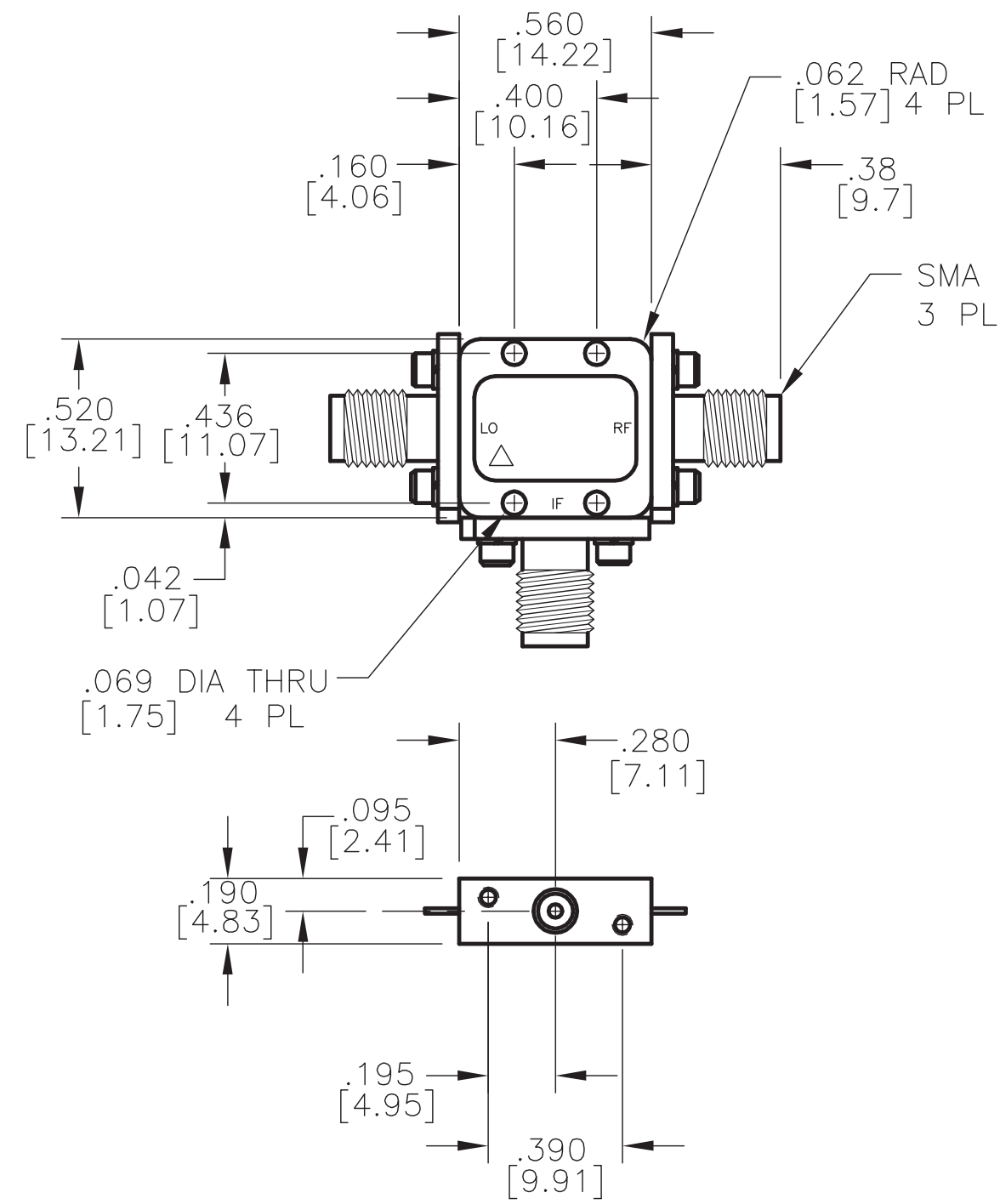

REVISIONS				
ECN	REV	DESCRIPTION	CHNG/DATE	APPVD/DATE
	B.1	ECN# 121001214	JD 11/9/04	JMM 11/11/04

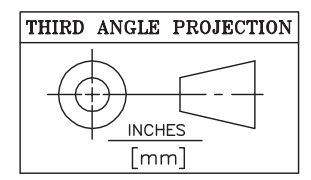

"MN" WITHOUT CONNECTORS
 "PN" WITH REMOVABLE CONNECTORS

TOLERANCE:
 INCHES .XX±.02
 .XXX±.010
 mm .X±.5
 .XX±.25



PROPRIETARY NOTICE THIS DWG IS THE PROPERTY OF SPECTRUM MICROWAVE INC. NEITHER RECEIPT NOR POSSESSION THEREOF CONFERS OR TRANSFERS ANY RIGHT IN OR LICENSE TO USE ANY DESIGN OR TECHNICAL INFORMATION HEREON NOR ANY RIGHT TO REPRODUCE THIS DWG IN WHOLE OR IN PART WITHOUT THE WRITTEN CONSENT OF SPECTRUM MICROWAVE INC. IT IS ISSUED ONLY ON THE EXPRESS CONDITION THAT ITS TECHNICAL CONTENT WHETHER PATENTED OR NOT WILL BE RESPECTED			TOLERANCES (INCHES) .XX = ± .02 X/X = ± 1/32 .XXX = ± .010 X' = ± 1' 0"		CONTRACT NO. DRAWN S. COX DATE 9/6/02 PROC ENGRG ENGRG MFG QA		 2144 Franklin Drive N.E. Palm Bay, Florida 32905	
			MATERIAL 		FINISH 		MARK WHERE SHOWN 	
RELEASE DATE _____	JOB NO. _____	SCALE: 2/1 APPROX WT		DWG NO. 080-25299-0001 REV B.1		SHEET 1 OF 1		