

DESCRIPTION

- 307.2 MHz SAW bandpass filter with 80 MHz bandwidth.
- 5 x 5 mm ceramic LCC package.
- RoHS compliant.

TYPICAL PERFORMANCE

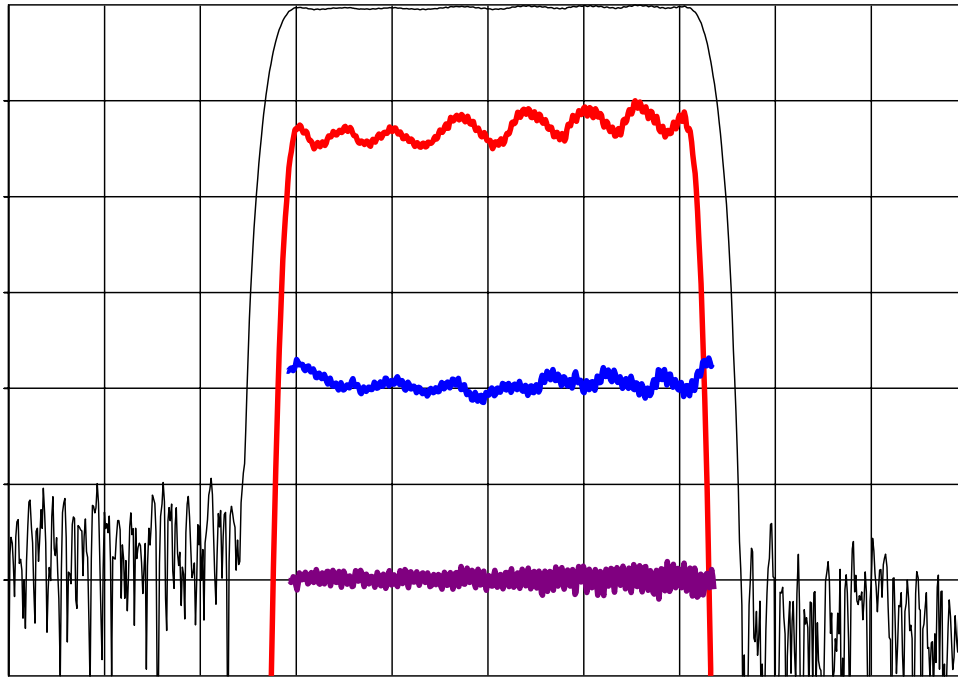

Horizontal:	Frequency	20	MHz /div
Vertical (from top):	Magnitude	10	dB/div
	Magnitude	1	dB/div
	Phase Deviation	5	deg/div
	Group Delay Deviation	50	ns/div

S11 (207.2-407.2 MHz)

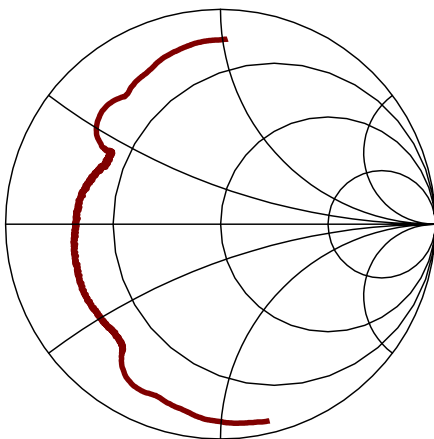

S22 (207.2-407.2 MHz)

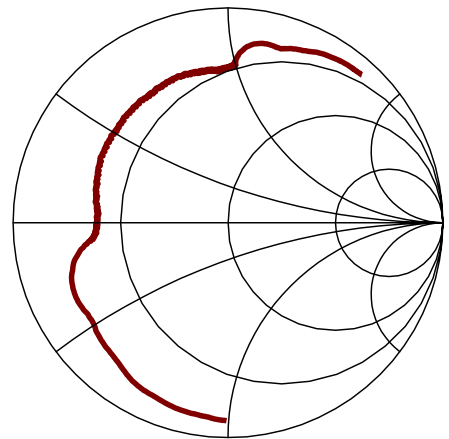

SPECIFICATION

Parameter ²	Min	Typ	Max	Units
Center Frequency (Fc) ¹	-	307.2	-	MHz
Minimum Insertion Loss	-	20.9	22	dB
1 dB Bandwidth	80	85.4	-	MHz
Lower 38 dB Band Edge	247.2	257.1	-	MHz
Upper 38 dB Band Edge	-	358.7	367.2	MHz
Rejection (0.3 to 30 MHz)	30	48	-	dB
Rejection (30 MHz to 247.2 MHz)	40	48	-	dB
Rejection (367.2 to 500 MHz)	38	55	-	dB
Passband Ripple (267.2 to 347.2 MHz) ²	-	0.6	1.0	dB p-p
Phase Linearity (267.2 to 347.2 MHz) ²	-	2	8	deg p-p
Group Delay Deviation (267.2 to 347.2 MHz) ²	-	20	60	ns p-p
Source and Load Impedance	-	50	-	Ω
Input Power	-	+10	+13	dBm

- Notes: 1. Average of the 3 dB band edge frequencies.
2. Specification applies to temperature range.

MAXIMUM RATINGS

Parameter	Min	Max	Units
Storage Temperature Range	-40	85	$^{\circ}\text{C}$
Operating Temperature Range	-10	85	$^{\circ}\text{C}$
Input Power Level	-	+13	dBm

MATCHING CIRCUIT

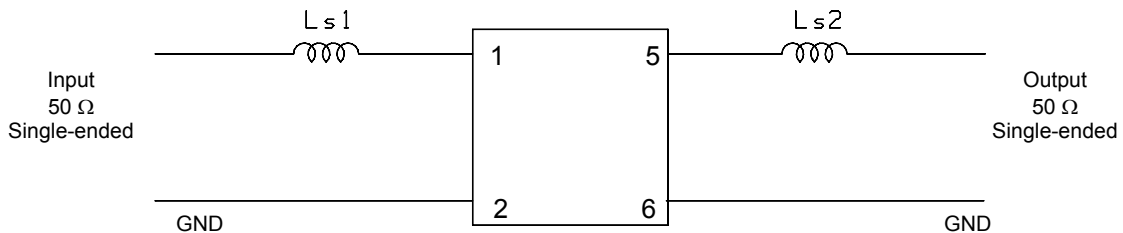

Typical component values: $L_{s1} = 39 \text{ nH}$ $L_{s2} = 52 \text{ nH}$

Notes:

1. Recommend +/-2% tolerance matching components. Typical inductor Q=40.
2. Tuning values shown are for reference only. Optimum values may change depending upon board layout.

PACKAGE OUTLINE

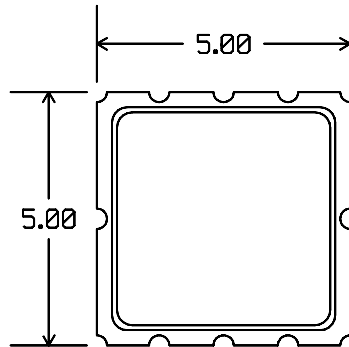

Units: mm

Tolerances are ± 0.15 mm except where indicated.

Pad Configuration:

Input: 1
Input Return: 2
Output: 5
Output Return: 6
Ground: All other pads

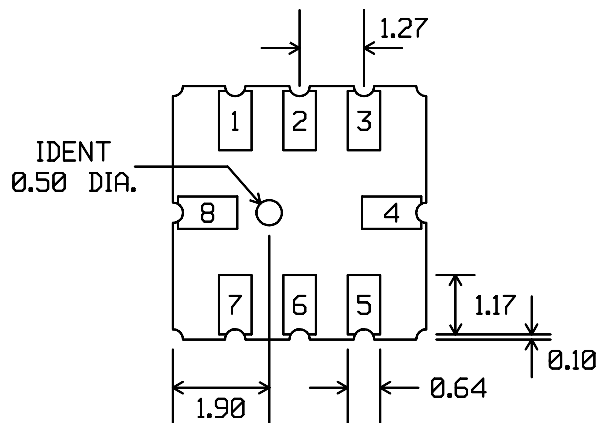
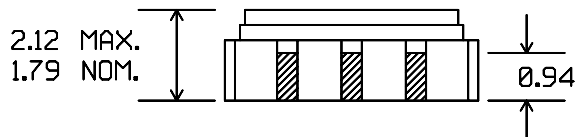

Package Material:
Body: Al_2O_3 ceramic
Lid: Kovar, Ni plated
Terminations: Au plating 1 μ m
min, over a 1.3-8.9 μ m Ni plating

ISO 9001
Registered

All specifications are believed to be accurate and reliable. However, Spectrum Microwave reserves the right to make changes without notice.
© 2010 All rights reserved.